

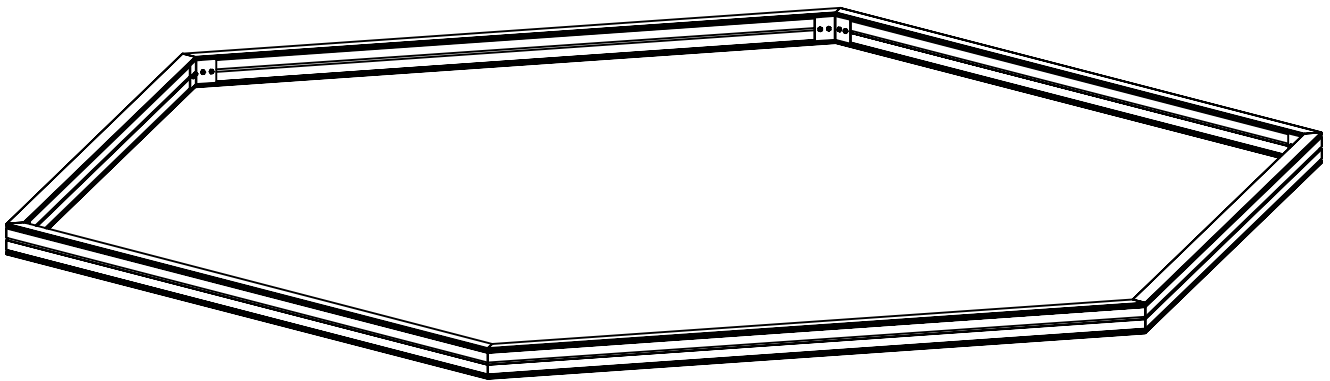











Monteringvejledning



MODEL: SCANDIC ODIN 8
ALUMINIUM SOKKEL

MÅL 346 x 300

Læs hele vejledningen før montering

DEL	NR.	STK.
 1755.3mm	DJ01	6
	D107	6
	D75	12
 Ø6,5XØ16x1	H79	12
	D76	12
 Ø5X40	Z13	12
 M6X10	S14	24
 M6	M03	36
 TSM6X14	S16	12

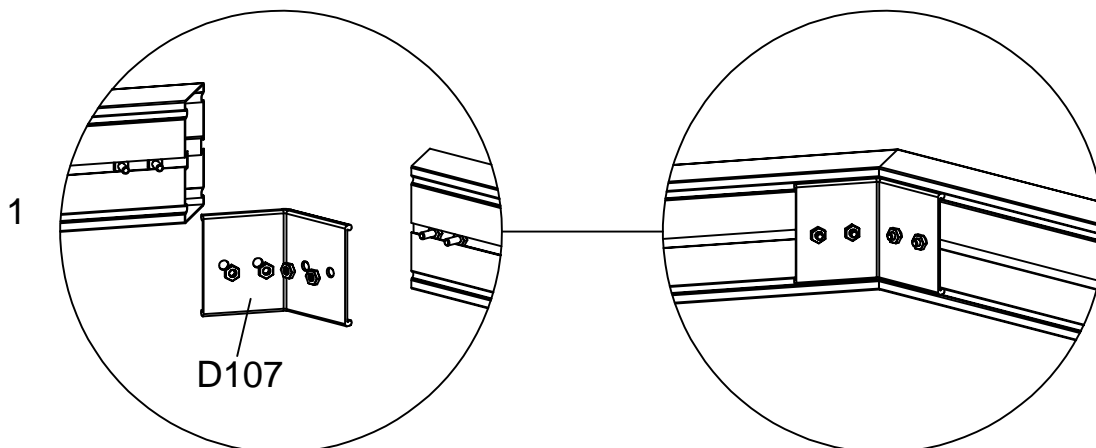
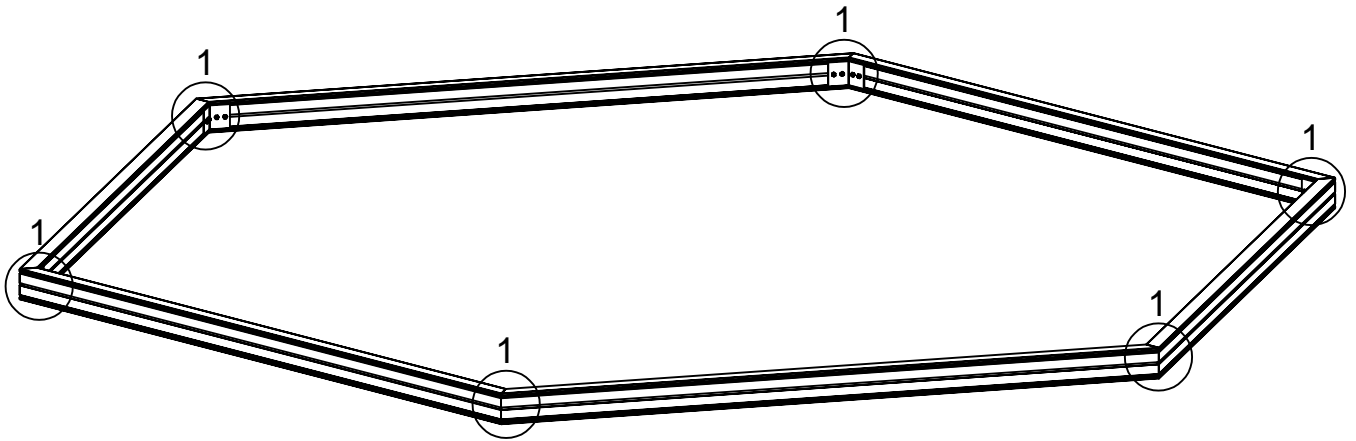

Saml alle DJ01 med samlebeslag D107.
Spænd dem derefter
med S14 og M03.

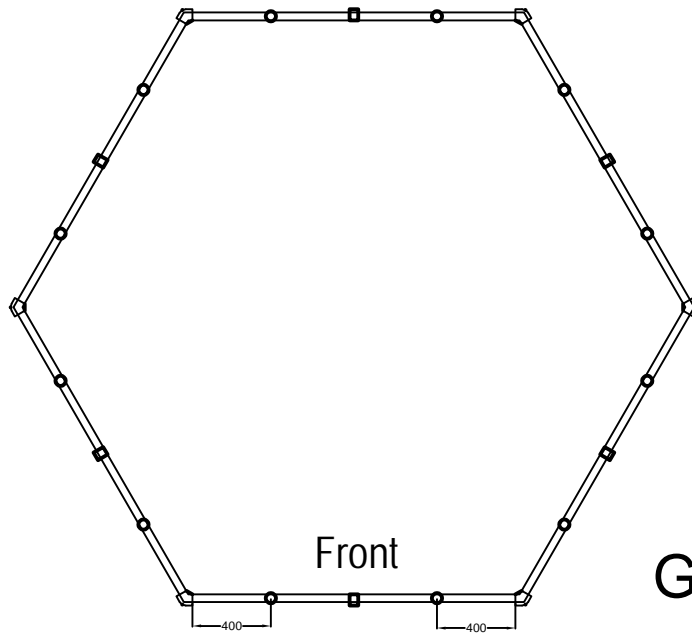

GE602

Placer først spærrene,
saml med samle- og
ankerbeslagene. Spænd
derefter med medfølgende
bolte og møtrikker.

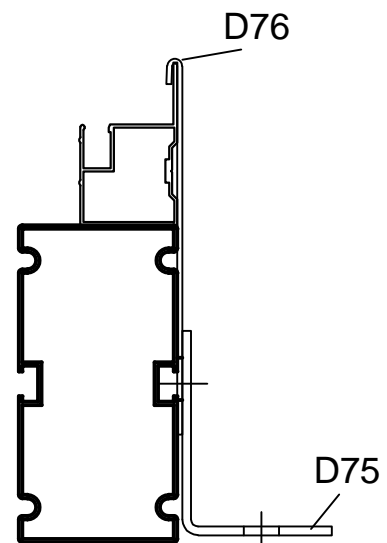
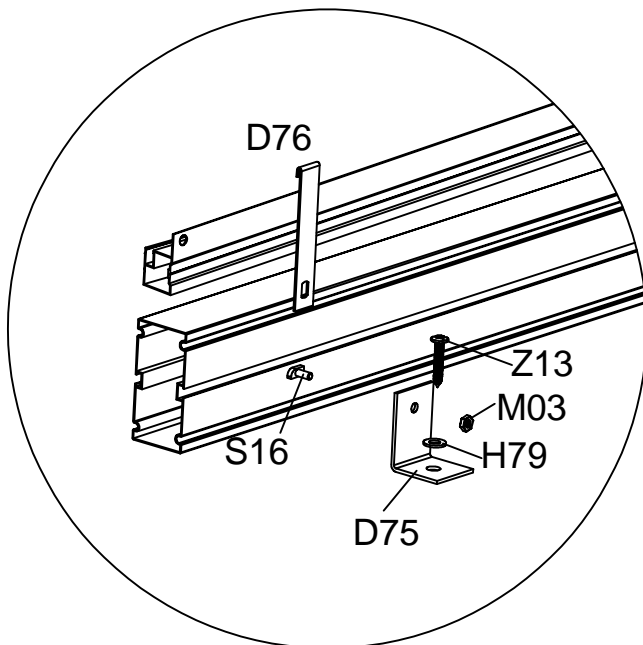

Tegningen viser D75 & D76's
placering i sokkelprofilen.